

# Technical Data Sheet

CODE 30309

C31/4T ATEX II 2G/D H  
T3/125°C X GB/DB



Centrifugal fans for installation in potentially explosive areas



## Certifications

CE ATEX-CE

EAC

## TECHNICAL AND PERFORMANCE DATA

Absorbed Current max (A)	1,01	Number of speeds	1
Absorbed Power max (W)	375	Voltage (V)	400
Frequency (Hz)	50	Weight (Kg)	10,5
Insulation Class	I°	Delivery max (l/s)	311,1
IP	65	Delivery max (m³/h)	1120
Max ambient temperature for continuous operation (°C)	+ 40	Pressure max (mmH2O)	31
Min ambient temperature for continuous operation (°C)	- 20	Pressure max (Pa)	304
Number of Phases (Ph)	3	RPM	1400
Number of Poles	4	Sound Pressure level Lp [dB (A)] 3m	61

## DIMENSIONS

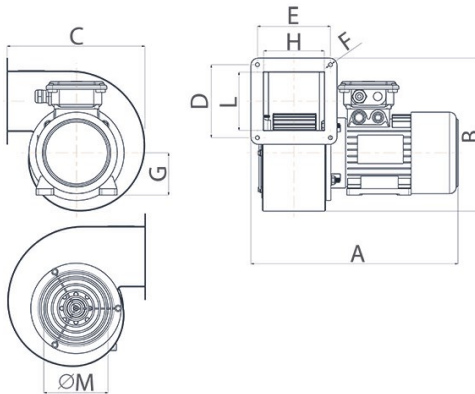

Dimensione Q (mm)	136
Dimensione R (mm)	90
Size A (mm)	365
Size B (mm)	400
Size C (mm)	340
Size D (mm)	164
Size E (mm)	139
Size F (mm)	8,5
Size G (mm)	71
Size H (mm)	112
Size L (mm)	137
Size M (mm)	170
Size N (mm)	190
Size O (mm)	165
Size P (mm)	112
Size S (mm)	108

### PER INFORMAZIONI:

Servizio al Cliente: tel +39 02 90699395 premendo 1 dopo messaggio registrato (consulenza su prodotti e impianti)

Pre & Post Vendita: fax +39 02 90699302

Email prevendita: [prevendita@vortice-italy.com](mailto:prevendita@vortice-italy.com)

# Technical Data Sheet

CODE 30309

C31/4T ATEX II 2G/D H  
T3/125°C X GB/DB



Centrifugal fans for installation in  
potentially explosive areas

## DESCRIPTION

- Scroll made of pressed steel, pickled and phosphated, and treated initially with epoxy base coat; thereafter, grey textured finish obtained by applying a coat of polyurethane powder paint strengthened by oven baking. Scroll housings drilled with holes to allow repositioning of the outlet port (LG90).
- Inlet port made of copper.
- Mesh grille on inlet port made of steel wire, zinc-coated, pickled and phosphated, epoxy powder coated and baked in oven, colour black.
- Frame and scroll: painted pressed steel, with multiple fixing holes configured to allow alignment of the motor in 8 different positions relative to the outlet port (see drawing attached).
- 1 speed three-phase AC motor with shaft turning in double shielded ball bearings, size to UNEL MEC standard, flange B35, manufactured employing methods and materials suitable for use in environments

- with potentially explosive atmospheres, according to Explosion Protection standards EN ISO 80079-36:2016; EN 14986:2017.
- Centrifugal impeller made of aluminium, with forward blades and diecast aluminium hub.
- Maximum air flow 1120 m<sup>3</sup>/h
- Aluminium cooling fan
- Pressed steel motor cover.
- Metal cable gland for electrical connection.
- Wiring box enclosure rating IP65.
- IMQ-certified for use in areas at risk of explosion due to presence of gas and dust:
- IMQ 10 ATEX 029 X; GR II cat. 2G/D h T3/125 X

## CURVES

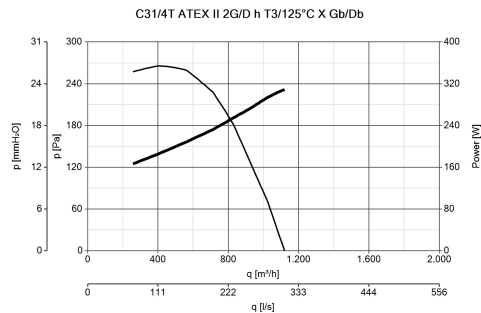

## ACCESSORIES



C-RA 31/35  
ATEX(RACCORDO  
DI  
ASPIRAZIONE)  
Code 21035



GV2 ME06  
Code 21115

### PER INFORMAZIONI:

Servizio al Cliente: tel +39 02 90699395 premendo 1 dopo messaggio registrato (consulenza su prodotti e impianti)  
Pre & Post Vendita: fax +39 02 90699302  
Email prevendita: [prevendita@vortice-italy.com](mailto:prevendita@vortice-italy.com)