

3 VENTILATOARE CENTRIFUGALE



RALR

VENTILATOARE CENTRIFUGALE
MONOASPIRANTE DE JOASA PRESIUNE

SINGLE SUCTION, INDUSTRIAL RADIAL FANS
(FORWARD CURVED) SPARSE WING
LOW PRESSURE

RALR, ventilatoare de joasa presiune. Pot fi utilizate in toate tipurile de ventilatie. Montaj si instalare usoare. Este una dintre cele mai economice solutii de ventilatie. Curatarea elicei este usor de realizat.

CONSTRUCTIE

Carcasa este realizata din tabla neagra DKP acoperita cu pulbere electrostatica. Turbina este metalica cu pale orientate inainte.

APLICATII

Spatii industriale si comerciale, fabrici, bucatarii, spitale, hote, birouri, laboratoare, centre comerciale, restaurante, teatre, apartamente, cluburi de noapte etc.

RALR low pressure systems. These fans designed for all kinds in plant ventilation they can be used. Screw mounting. Easy to install. One of the most economical installation solution. The wing structure is sparse thanks to propeller cleaning is easy.

MATERIAL

The assembly is electrostatic powder coated DKP. It is made of black sheet. Radial fan, forward DKP black with curved sparse propeller structure. Made of sheet metal.

USAGE AREAS

It can be used in industrial and constructional applications, factories, kitchens, hospitals, hoods, offices, laboratories, malls, restaurants, theaters, flats, nightclubs etc.

Tip/Cod Type/Code	Motor / Electrical Motor			Debit maxim Air Flow m ³ / h	Presiune Pressure Pa	
	Voltaj Voltage (V)	Putere Power (HP)	Speed Speed (d/d) (rpm)			
			(kW)			
RALR-0,50-T-4K	380	0,50	0,37	1.380	2.000	400
RALR-1,00-T-4K	380	1,00	0,75	1.410	3.500	500
RALR-1,50-T-4K	380	1,50	1,10	1.430	4.500	600
RALR-2,00-T-4K	380	2,00	1,50	1.430	5.500	700
RALR-3,00-T-4K	380	3,00	2,20	1.435	7.000	800
RALR-4,00-T-4K	380	4,00	3,00	1.435	8.000	900
RALR-5,50-T-4K	380	5,50	4,00	1.455	9.000	1.000
RALR-7,50-T-4K	380	7,50	5,50	1.465	12.000	1.100
RALR-10,0-T-4K	380	10,0	7,50	1.465	14.000	1.200

Discover the potential



DIMENSIUNI/ TECHNICAL DIMENSION

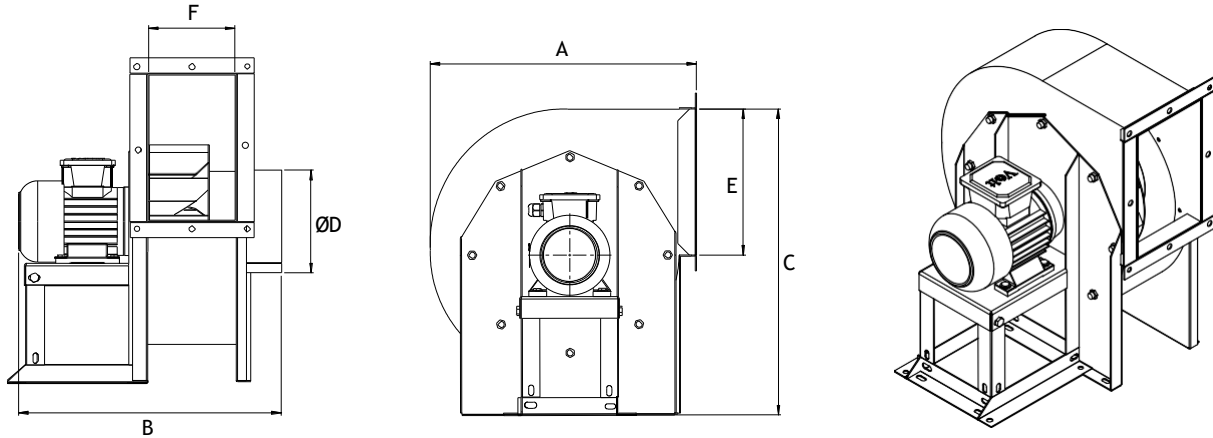

Tip/Cod Type/Code	Dimensiuni / Sizes (mm)					
	A	B	C	D	E	F
RALR-0,50-T-4K	470	420	620	Ø 200	250	180
RALR-1,00-T-4K	470	420	620	Ø 200	250	180
RALR-1,50-T-4K	520	490	650	Ø 240	260	200
RALR-2,00-T-4K	570	510	680	Ø 260	280	220
RALR-3,00-T-4K	610	600	715	Ø 320	300	230
RALR-4,00-T-4K	610	610	760	Ø 320	300	250
RALR-5,50-T-4K	630	710	790	Ø 350	360	280
RALR-7,50-T-4K	720	800	880	Ø 350	490	330
RALR-10,0-T-4K	770	850	960	Ø 400	530	380

RALR-0,50-T-4K

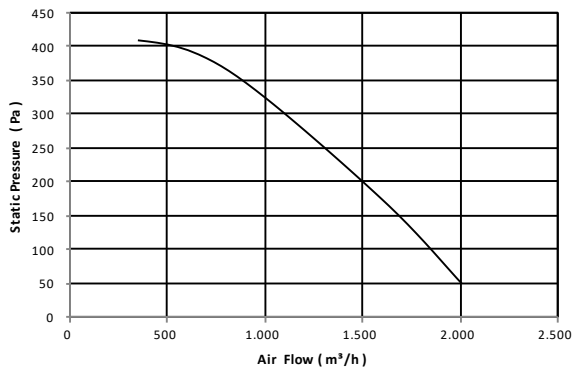

RALR-1,00-T-4K

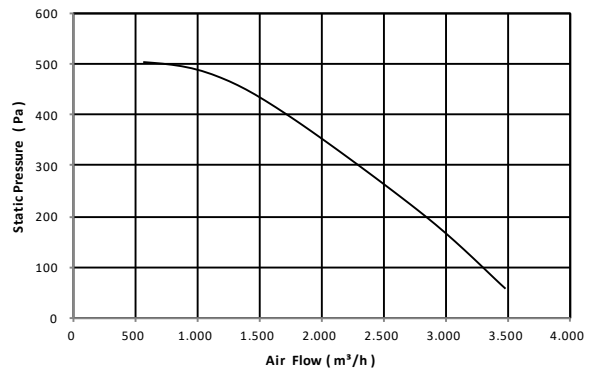

CURBE DE FUNCTIONARE/ PERFORMANCE CURVES

RALR-1,50-T-4K

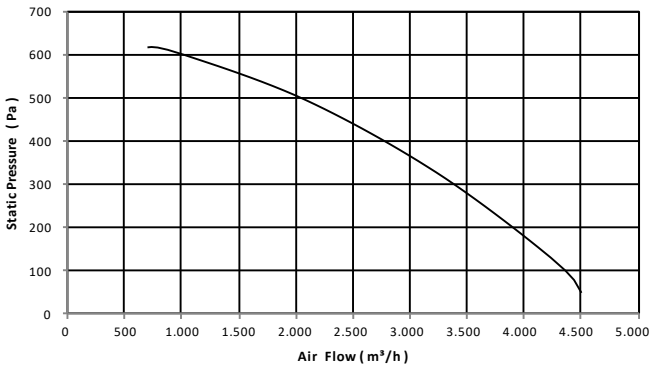

RALR-2,00-T-4K

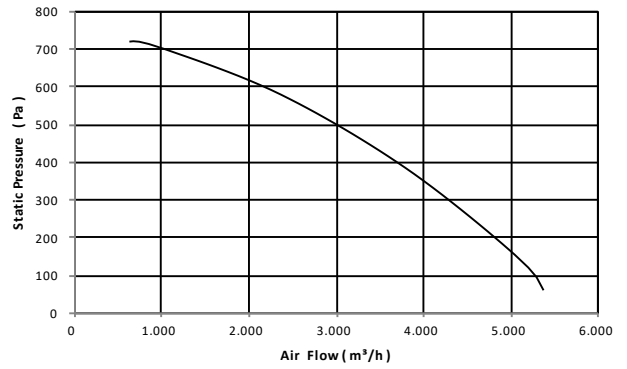

RALR-3,00-T-4K

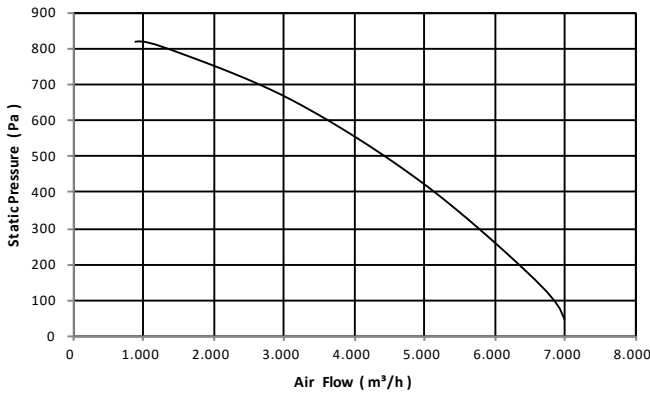

RALR-4,00-T-4K

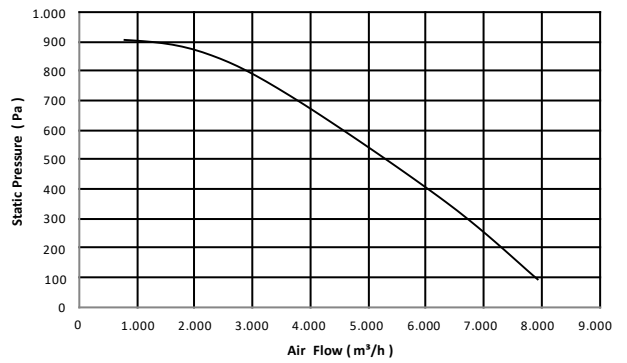

Discover the potential



CURBE DE FUNCTIONARE/ PERFORMANCE CURVES

RALR-5,50-T-4K

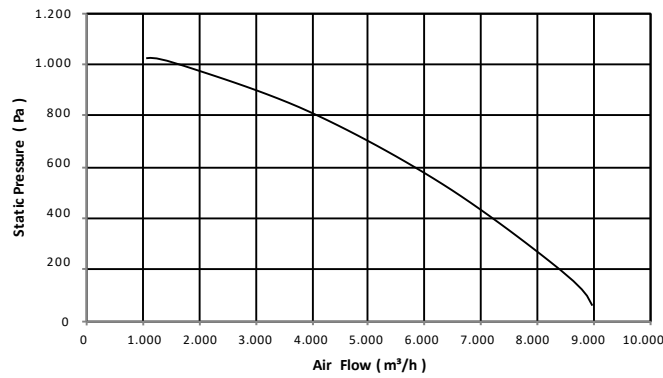

RALR-7,50-T-4K

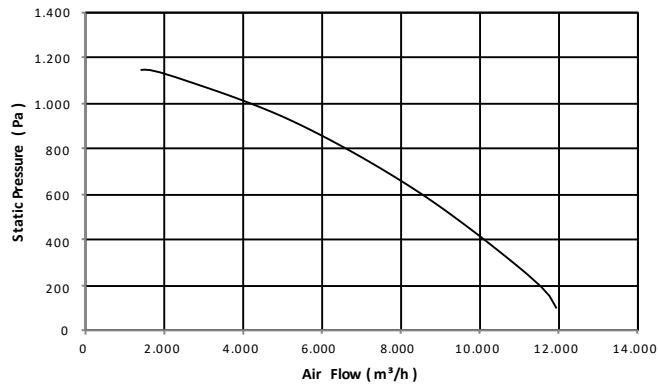

RALR-10,0-T-4K

